

9103FZ – KZ9103

MONORACK SPECIFICO – SPECIFIC MONORACK – MONORACK SPECIFIQUE – SPEZIFISCHES MONORACK – MONORACK ESPECÍFICO – MONORACK ESPECÍFICA

KEEWAY RKF125(2018 / 2020)

| N° | Descrizione/Description | Caratteristiche/Features | Codice/Code | Quantità/Quantity |
|----|--|---|------------------------|-------------------|
| 1 | Supporto laterale - Lower frame -Support latéral -Soporte lateral Untere Halterung - Suporte lateral | - | 9103FZDXV 9103FZSXV | 2(Right,Left) |
| 2 | Supporto superiore - Support higher - Support supérieur Halterung höher - Soporte superior - Apoio superior | - | GL4594DXV GL4594SXV | 2(Right,Left) |
| 3 | Piastra di supporto - Support plate -Plaque de support - Trägerplatte Pletina de soporte - Placa de apoio | - | GL4593V | 1 |
| 4 | Supporto inferiore - Lower support - Support inférieur Soporte inferior - Untere Halterung - Suporte inferior | - | GL4595V | 2 |
| 5 | Vite - Screw - Vis - Schraube Tornillo - Parafuso | TECF M6x20 | 620TECF | 2 |
| 6 | Vite - Screw - Vis - Schraube Tornillo - Parafuso | TECF M6x40 | 640TECF | 4 |
| 7 | Vite - Screw - Vis - Schraube Tornillo - Parafuso | TBEIFH M8x30 | 830TBEIFH | 8 |
| 8 | Rondella spaccata - Split washer Scheibe - Rondelle fendue Arandela seccionada - Arruela Dentada | Ø6 | Z1063 | 6 |
| 9 | Rondella - Washer - Rondelle Scheibe - Arandela - Arruela | Foro Ø6mm Esterno Ø18mm Sp.1,5mm | 618RON | 6 |
| 10 | Distanziale - Spacer Entretoise - Distanzstueck Distanciador - Espaçador | Ø20x10 Foro 8,5mm | C20L10F8,5T | 4 |
| 11 | Distanziale - Spacer Entretoise - Distanzstueck Distanciador - Espaçador | Ø12x12 Foro 8,5mm | C12L12F8,5T | 8 |
| 12 | Dado - Bolt - Ecrou - Mutter Tuerca - Porca | Dado Autobloccante Flangiato M8 (H9,5mm) | 8DADIFN | 8 |
| 13 | Componenti Originali - Original Parts Parties Originales - Original Bauteile Componentes Originales - Componentes Originais | - | - | - |
| 14 | Particolari Inclusi Nel Kit Viteria Della Piastra Components Included In The Fitting Kit Of The Plate Pièces Inclues Dans Le Kit De Vis De La Platine Die Einzelnen Teile Sind Bei Montagekit Der Platte Enthalten Despieces Incluidos En El Kit De Anclajes De La Parrilla Explodiu Incluído No Kit As Âncoras Da Grelha | - | - | - |

9103FZ - KZ9103

MONORACK SPECIFICO - SPECIFIC MONORACK - MONORACK SPECIFIQUE - SPEZIFISCHES MONORACK - MONORACK ESPECÍFICO - MONORACK ESPECÍFICA

KEEWAY RKF125(2018 / 2020)

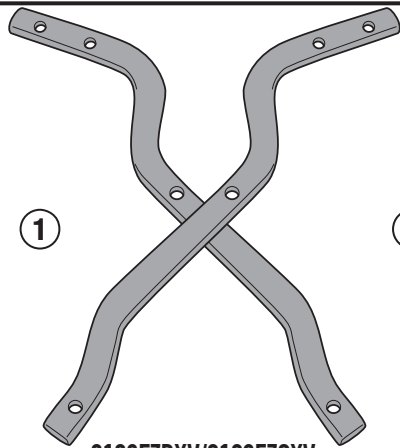

1

9103FZDXV/9103FZSXV

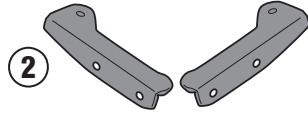

2

3

GL4594DXV/GL4594SXV

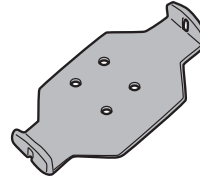

4

GL4593V

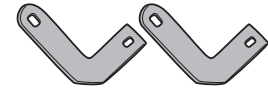

GL4595V

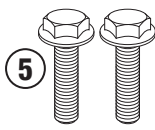

M6x20mm

6

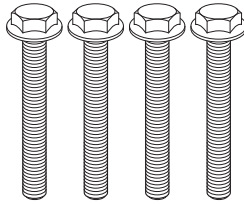

M6x40mm

7

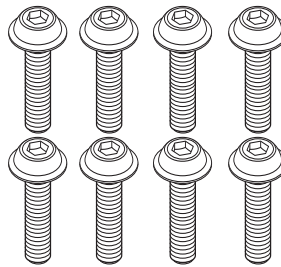

M8x30mm

8



Ø6mm

9



Hole Ø6mm/
External Ø16mm/
D.2mm

10



Hole Ø8.5mm/
External Ø20mm/
H.10mm

11

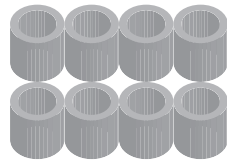

Hole Ø8.5mm/
External Ø12mm/
H.12mm

12

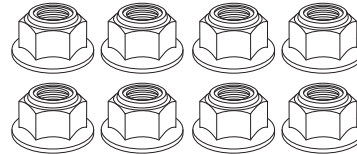

M8

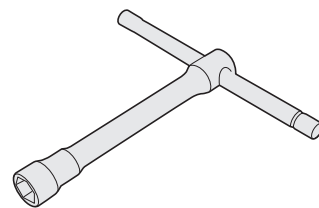
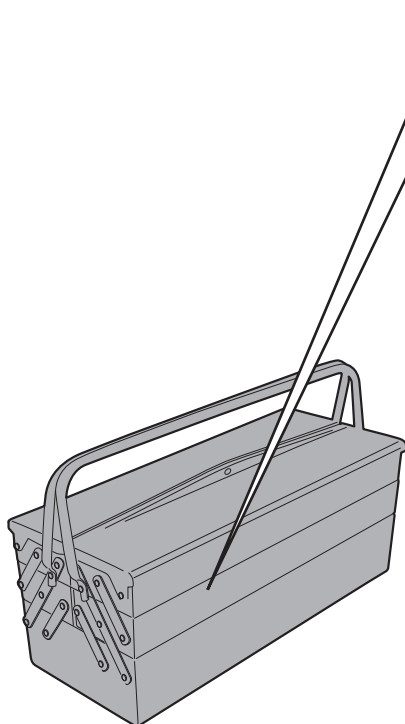

8mm - 10mm

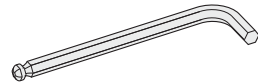
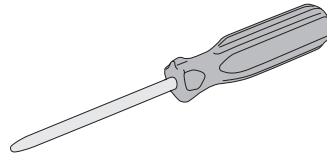

4mm - 5mm

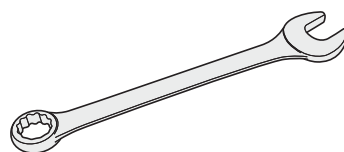

13mm



9103FZ - KZ9103

MONORACK SPECIFICO - SPECIFIC MONORACK - MONORACK SPECIFIQUE - SPEZIFISCHES MONORACK - MONORACK ESPECÍFICO - MONORACK ESPECÍFICA

KEEWAY RKF125(2018 / 2020)

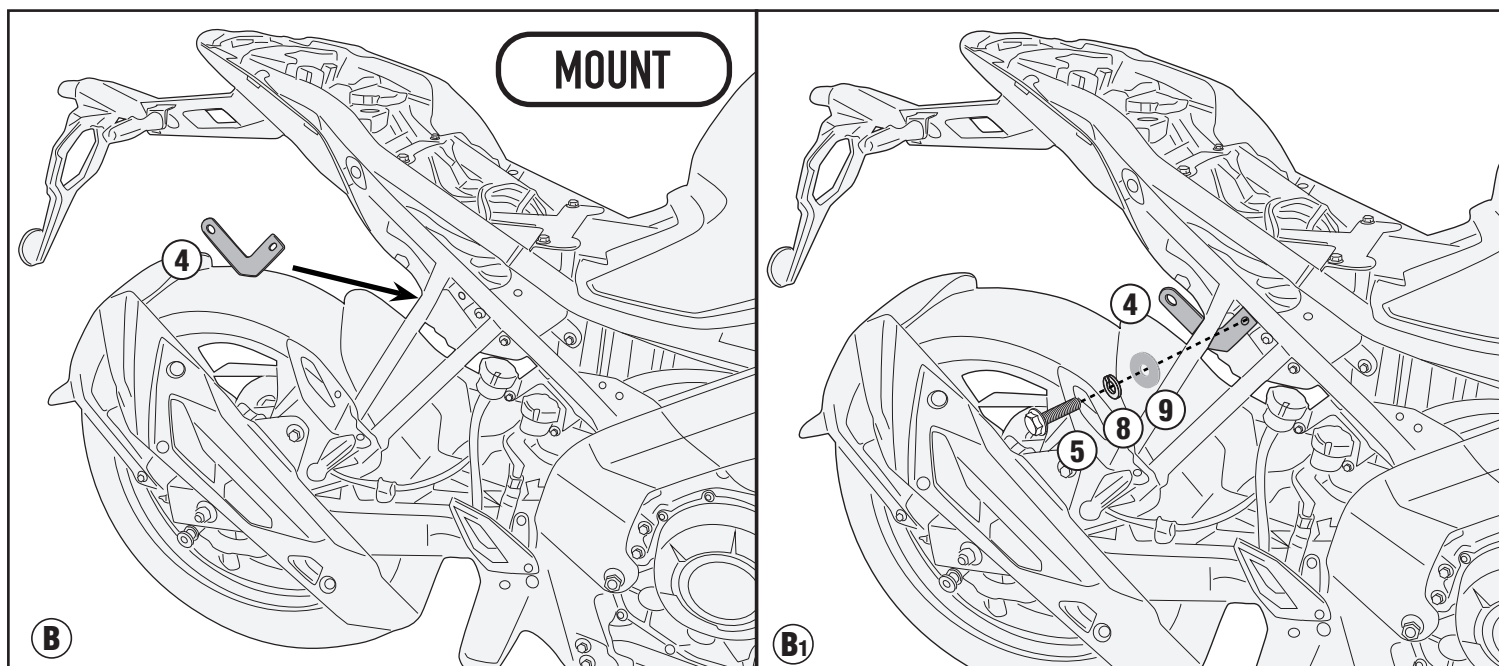
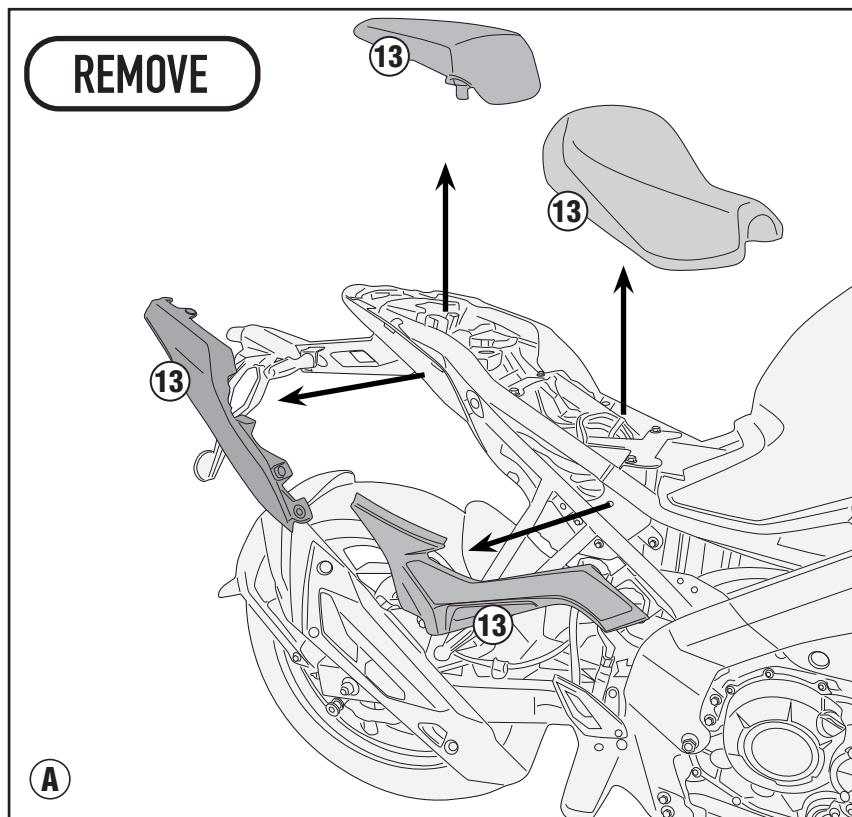

9103FZ - KZ9103

MONORACK SPECIFICO - SPECIFIC MONORACK - MONORACK SPECIFIQUE - SPEZIFISCHES MONORACK - MONORACK ESPECÍFICO - MONORACK ESPECÍFICA

KEEWAY RKF125(2018 / 2020)

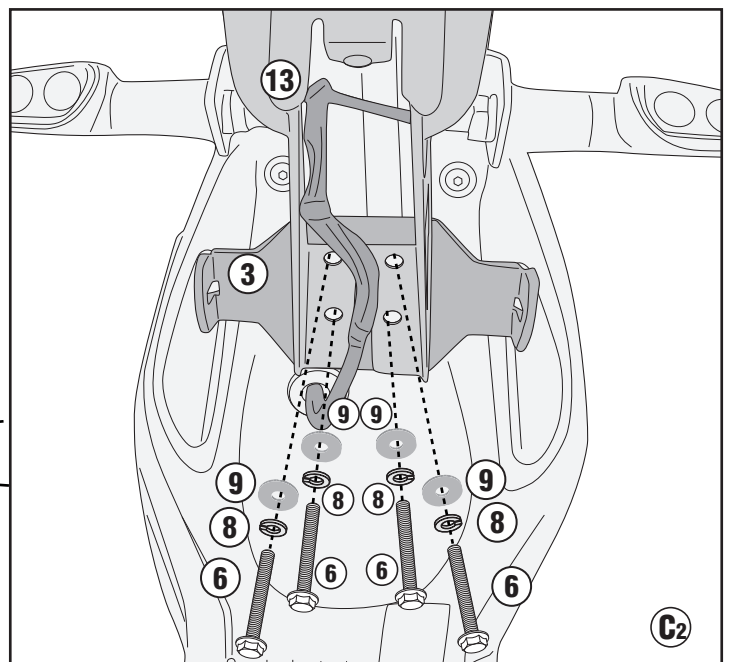
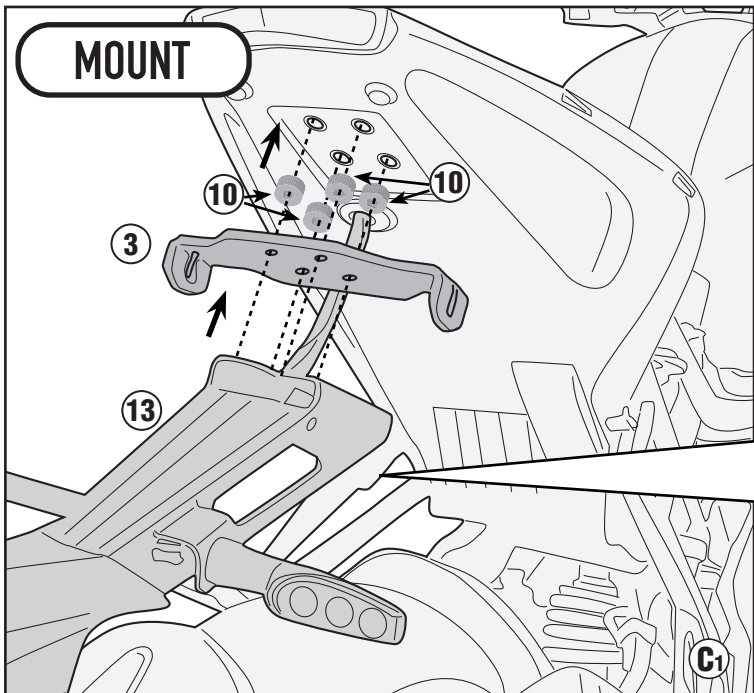
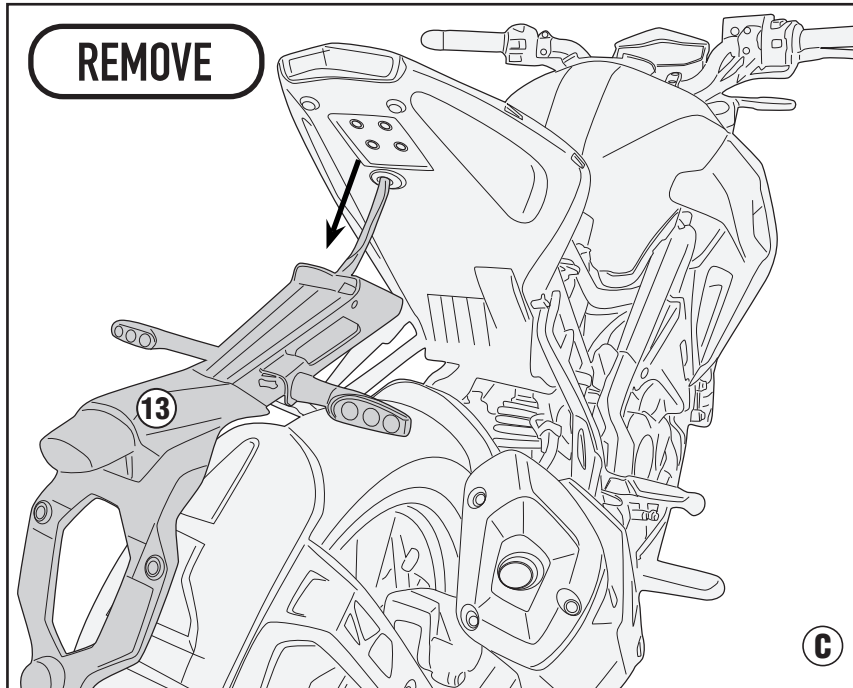

9103FZ - KZ9103

MONORACK SPECIFICO - SPECIFIC MONORACK - MONORACK SPECIFIQUE - SPEZIFISCHES MONORACK - MONORACK ESPECÍFICO - MONORACK ESPECÍFICA

KEEWAY RKF125(2018 / 2020)

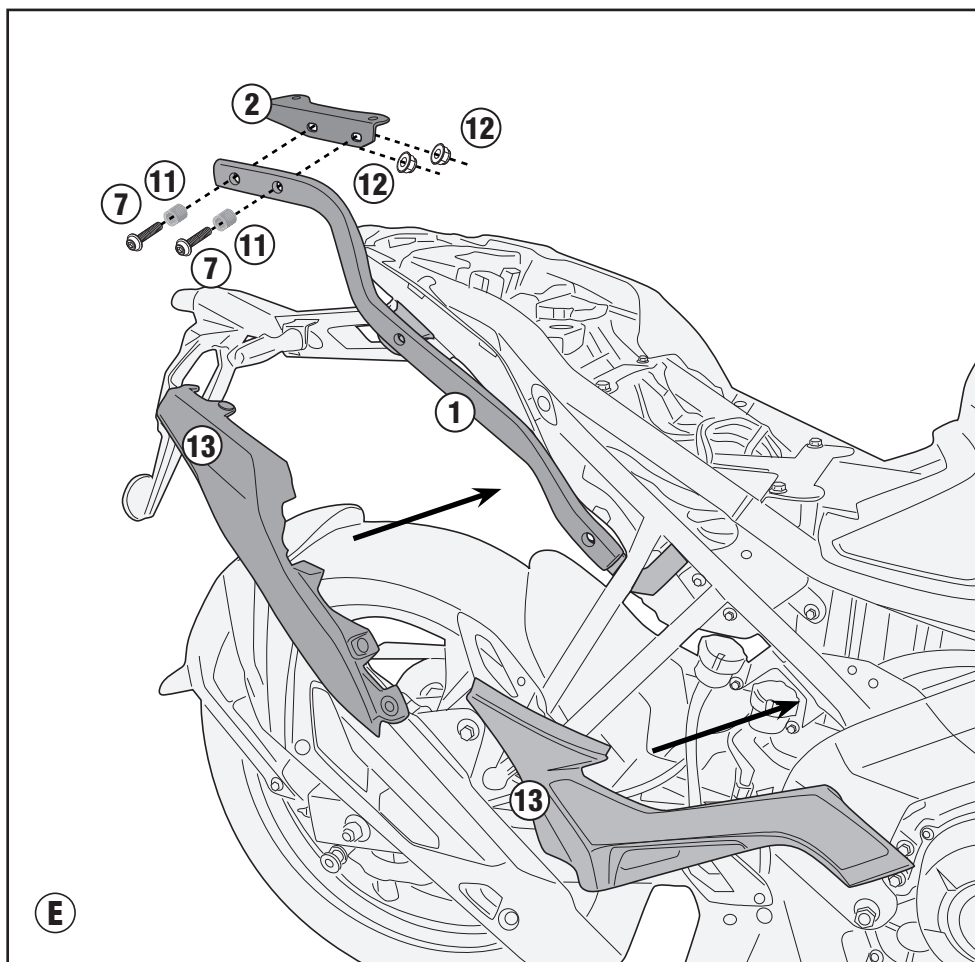
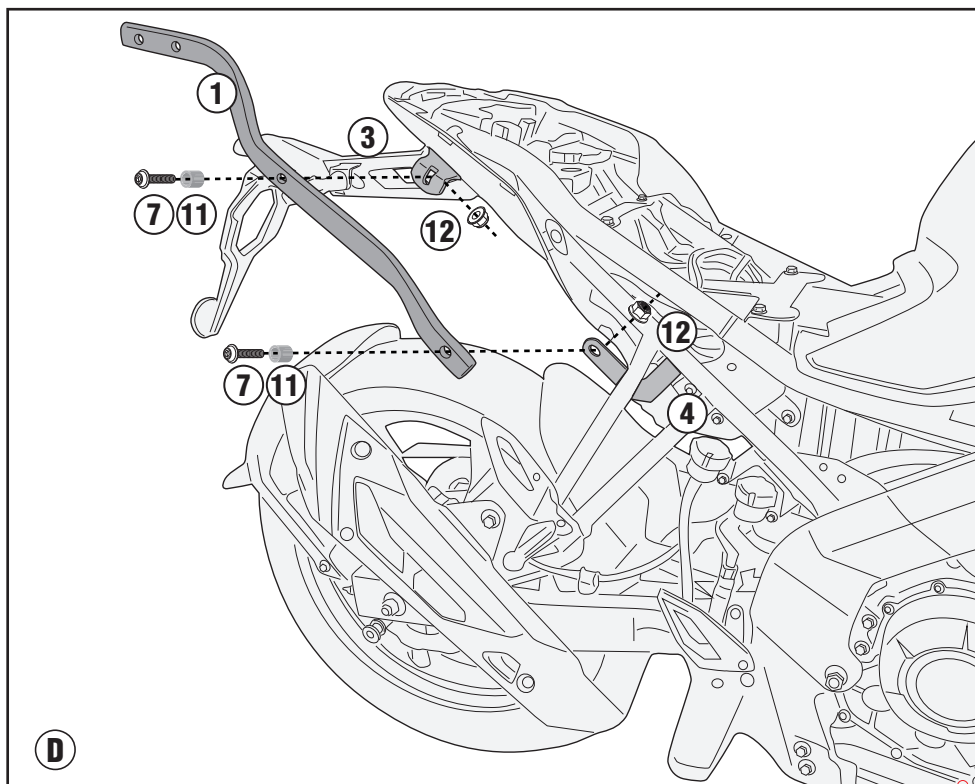

9103FZ - KZ9103

MONORACK SPECIFICO - SPECIFIC MONORACK - MONORACK SPECIFIQUE - SPEZIFISCHES MONORACK - MONORACK ESPECÍFICO - MONORACK ESPECÍFICA

KEEWAY RKF125(2018 / 2020)



ONLY Z113C2 PLATE

